

This brochure has been compiled by DaimlerChrysler AG of Germany and is distributed internationally. It provides a general indication of the range of models, features, optional extras and/or colours available in various countries. Some of the models, features, optional extras and/or colours shown may not be available in your country or may only be available in a different specification. Additionally some models, features, optional extras and/or colours may only be available in combination with others. For current and more specific information in relation to the range of models, features, optional extras and/or colours available in your country, and their pricing, you should contact your nearest authorised Mercedes-Benz Passenger Car Dealer.





THE C-CLASS SALOONS



Mercedes-Benz

The C-Class Saloon. An elemental experience





Contents

04	The C-Class Saloons
08	Engines
10	Dynamic handling
16	Comfort
22	Design
28	Sports packages
32	AMG
36	Safety
42	Equipment
46	Optional extras
52	Accessories
54	designo
56	Paintwork and upholstery
60	Technical data
62	Dimensions
64	Glossary

C350 AVANTGARDE with sports package





S 0A 5665





C 350 AVANTGARDE with sports package

One of our key raw materials is undiluted passion

There are certain things you can never have too much of, yet which, thankfully, are available in limitless supply. Take, for example, our passion for developing cars like the C-Class. Its comfort and safety features set new standards in its class. As do the new-generation 6-cylinder engines. Whether you opt for the diesel-powered C 320 CDI or the petrol-driven C 230, C 280 or C 350, the output and torque figures give the C-Class that all-important leading edge. But there are other factors behind the excellent dynamic handling too: the DIRECT CONTROL suspension ensures outstanding agility, and the precision-tuned suspension harmonises perfectly with the DIRECT CONTROL 6-speed manual transmission, resulting in shorter shift travel for enhanced dynamism you can feel.

The dynamism of the C-Class is clearly reflected in its looks too, with clear-lens headlamps, a front apron with large air intakes, a powerful-looking, three-slat radiator grille, side skirts, a sporty rear bumper and dark red high-gloss tail lights.

Quiet self-assurance, backed up by formidable power reserves

No other engines in the relevant displacement classes manage to combine dynamic handling with smoothness and supreme performance as successfully as the new 6-cylinder petrol engines in the C 230, C 280 and C 350. Driving pleasure in the C-Class begins with the C 180 KOMPRESSOR, which delivers a 105-kW (143-hp) output and is impressively fuel-efficient. The C 200 KOMPRESSOR offers even more power. And the true top-flight athlete of the range is the C 55 AMG, with its 5.5-litre AMG V8 engine and an output of 270 kW (367 hp).

The economical CDI engines also deliver undiluted driving pleasure. They comply with the EU4 emission limits and are fitted as standard with a particulate filter, which significantly reduces emissions. The diesel fuel is injected into the combustion chambers at a pressure of up to 1600 bar, ensuring impressive tractive power. The result is an output which ranges from 90 kW (122 hp) to 165 kW (224 hp) and a beefy maximum torque of up to 510 Nm in the C 320 CDI with 7G-TRONIC automatic transmission.





In the C-Class, the DIRECT CONTROL 6-speed manual transmission is responsible for translating the engine output into pure driving pleasure. The short, precise shift throw ensures precision gear changes. The 4-cylinder models can, as an option, be fitted with an electronically controlled 5-speed automatic transmission which reacts to your driving style (standard for 4MATIC models and the C 55 AMG).

You can also change gear manually, simply by nudging the selector lever or – for a particularly sporty feel – using optional gear-shift buttons on the steering wheel

10 Dynamic handling

C 350 AVANTGARDE with sports package





All 6-cylinder models (except the 4MATIC versions) can be fitted with the 7G-TRONIC 7-speed automatic transmission as an option. It reduces fuel consumption and offers significantly smoother gear changes. The seven forward gears also make for smaller shifts in the engine speed, accelerating the C-Class even more powerfully. And for a really exciting quick burst of speed, 7G-TRONIC can skip several gears when downshifting

4MATIC permanent all-wheel drive is available for your C-Class as an option. Its impressive stability is the result of the 4ETS traction system. Stepping in at the first sign that one or more of the driven wheels is starting to spin, the precisely metered brake intervention produces the same effect as up to three conventional differential locks, allowing ideal traction. Even in the wet, or on snow, slush or ice, 4MATIC demonstrates its strengths – these conditions provide welcome opportunities for the new C 280 4MATIC and C 350 4MATIC models to shine as all-weather performers

C 350 AVANTGARDE with sports package





Nothing can stop you now. Or the C-Class – combining, as it does, outstanding dynamic handling with top-class comfort. The key to this unique driving sensation is DIRECT CONTROL: special suspension tuning leads to significantly enhanced agility. And the new DIRECT CONTROL steering and DIRECT CONTROL transmission, with its shorter shift throw, ensure a sporty driving sensation without compromising on comfort

C 350 AVANTGARDE with sports package





True comfort is when the dream and reality match

You may well find that you enjoy having to take detours in the C-Class Saloon. Not just because of its impressive performance, but because of the luxurious on-board atmosphere too.

The spacious feel and the ergonomic, extra-comfortable seats could turn the interior of the Saloon into one of your favourite haunts – a preference reinforced by the standard THERMATIC automatic climate control system which has dust and pollen filters plus an air recirculation switch to ensure clean fresh air on board. Your set temperature remains constant, even when temperatures outside soar.

The optional PARKTRONIC system makes parking and manoeuvring easier. Its ultrasonic signals are bounced back off any obstacles in the car's path – within an area of between 15 and 80 centimetres at the front and between 20 and 120 centimetres at the rear. A display shows how much space is still available. If your C-Class comes within around 35 centimetres of another vehicle, the system emits an audible signal which becomes a permanent warning tone when the gap falls below approximately 20 centimetres.





The interior of the C-Class was designed with comfort and relaxation in mind. The feeling starts with the seats – thanks to their highly ergonomic form, you'll arrive feeling fresh and alert, even after a long journey. On the front seats the height of the seat cushion and the angle of the backrest can be adjusted electrically. To ensure that you are able to keep your hands on the wheel at all times there's a multifunction steering wheel. It allows you to operate the radio and CD player, call up information from the display and accept incoming phone calls at the touch of a button

C 320 CDI ELEGANCE









All news and information is supplied via the optional COMAND APS control and display system, which combines a DVD navigation system, CD player and radio. The system can be extended with an MP3-compatible CD changer, a harman/kardon LOGIC 7® surround sound system and the pre-installation for a mobile phone with a universal mobile interface. Another option is the Audio 50 APS with a CD drive. Like COMAND APS, it is optionally available with the LINGUATRONIC voice control system

Articulating a clear design concept. Listen to your eyes

Elegant solutions are clear, simple solutions. One of the most beautiful examples of this is the C-Class. Its elegance and its dynamism combine to give it a powerful and self-confident presence.

Allow your eyes to linger on its form, noting in particular the high-gloss, clear-lens headlamps, the new front apron with its large air intakes and the powerful-looking, three-slat radiator grille. These set the dynamic tone. The bumpers feature integral fog lamps which, in conjunction with the optional bi-xenon headlamps, are activated on cornering. The left or right fog lamp comes on, lighting up the inside of the corner to best effect. And side skirts merge into the sporty bumper at the rear. Whichever way you look at it, this is a car that's supremely sporty yet simply elegant.







The new radiator grille, with its three louvers, has a much broader and more powerful look. The louvers have different paint finishes depending on the equipment line. Light in its most attractive form: the C-Class features clear-lens headlamps and tail lights. The broad lower air intake underlines the sporty character of the C-Class







Colours can accentuate shapes – and the designs of the fabric upholstery inside the C-Class accentuate this car's style. Each of the three lines – CLASSIC, ELEGANCE and AVANTGARDE – now also features its own highly individual seat design. When you're on the move, the four clearly laid-out chronometer-style circular instruments, with their white back-lighting, provide the perfect overview. The instrument cluster forms the focal point of the all-new cockpit design







C 350 AVANTGARDE with sports package

An impeccable body.

With so much sport, it's little wonder

The sports package and the AMG sports package truly underline the dynamism of the C-Class. The sports package comprises sports suspension and 17-inch, 5-spoke light-alloy wheels, with mixed-size tyres, size 225/40 at the front and 245/40 at the rear. On the petrol models an oval-design, stainless steel exhaust tailpipe gleams at the rear, while the diesel models feature two chromed tailpipes. And because an athlete has to master more than just rapid acceleration, a sports braking system with perforated brake discs brings the C-Class to a standstill just as promptly.

The sports package also provides for more dynamism in the interior: sports seats provide perfect support for the driver and front passenger, particularly on bends. The seats can be upholstered either in TWIN Leather¹ or in leather (available as an optional extra).

When you want to put your foot down, there are studded pedals in brushed stainless steel. For steering there is a 3-spoke multifunction steering wheel with thumbrests and for changing gear a short leather-trimmed gearshift lever.

¹Combined leather/man-made leather upholstery

Sports packages





The AMG sports package includes all the equipment features of the sports package plus AMG bodystyling, which consists of a sporty front apron with integral fog lamps, a rear apron and side skirts. Sterling silver-painted 17-inch AMG light-alloy wheels in 5-spoke design, with size 225/45 tyres at the front and 245/40 at the rear, round off the AMG sports package





True passion can be summed up in three letters: AMG

The Mercedes-AMG specialists are people who really deserve to have the title “Car enthusiast” emblazoned on their business cards. The best example of their enthusiasm is perhaps the C 55 AMG: AMG 5.5-litre V8 engine, 270 kW (367 hp), maximum torque of 510 Nm, 0 to 100 km/h in 5.2 seconds – performance figures perfectly complemented by the AMG sports suspension and the AMG high-performance braking system. The C 55 AMG, however, is about more than impressive performance. It also has captivating looks, thanks to the independent front-end design and dynamic AMG bodystyling, consisting of front and rear aprons and side skirts. The interior of the C 55 AMG (pictured left) is equally lavish: exclusive nappa leather appointments and AMG sports seats count among the highlights here, alongside the AMG ergonomic sports steering wheel and the AMG instrument cluster.







Our first thoughts are of your safety

We're not of the opinion that pleasure necessarily entails risk: for a drive to be enjoyable it must be safe. Which is why you'll find the C-Class is packed with safety features invented and developed by Mercedes-Benz. The Electronic Stability Program (ESP®), Brake Assist (BAS) and the anti-lock braking system (ABS) help to avoid the risk of an accident. If an accident should, nevertheless, occur, the front airbags or sidebags and windowbags are selectively deployed according to the type and severity of the impact. Intelligent sensors recognise whether the impact is serious or relatively minor and inflate the front airbags in stages accordingly. The windowbags and sidebags offer additional protection for the head and chest area. In the event of a front or rear-end collision above a specific level of severity, belt tensioners on the front and outer rear seats pull the seat belts taut across the body in fractions of a second. The NECK-PRO head restraints for the driver and front passenger are a new feature in the C-Class. In the event of a rear-end collision, they provide more rapid support for the head and thus help to protect the neck vertebrae. Given the amount of all-round protection on board, it is little surprise that the C-Class not only achieved the top rating of 5 stars in the Euro NCAP safety test but was also awarded "Best Pick" by the renowned US insurance institute IIHS.





The Electronic Stability Program (ESP®) applies the brake to one or more of the wheels as required in critical on-road situations in order to stabilise the vehicle. The engine output is also automatically adjusted. Brake Assist (BAS) quickly brings you to a standstill. It can recognise an emergency situation from the speed with which you step on the brake and automatically builds up the maximum braking force





Far-sightedness in the C-Class comes courtesy of the powerful optional bi-xenon headlamps – with their new cornering function, they can turn even a night-time drive around the corner into an illuminating experience. One of the fog lamps is activated when the indicators are switched on or when the steering wheel reaches a specific angle and illuminates a broad area alongside and in front of the Saloon. Headlamp Assist, the standard-fitted light sensor, automatically activates the headlamps when it starts to get dark and in the rain or snow





The C-Class equipment lines. Express yourself

The C-Class is available in three different equipment lines: CLASSIC, ELEGANCE and AVANTGARDE. The CLASSIC model features eye-catching wheel trims which, together with the 16-inch tyres, create a beefy look. The ELEGANCE and AVANTGARDE models feature specific light-alloy wheel designs.

In the interior too there have been plenty of changes. Each line has its own independent look, with new fabric designs for the seats and new door trim. The CLASSIC model features Bristol fabric upholstery, the ELEGANCE model Windsor fabric upholstery and the AVANTGARDE model Coventry upholstery, a combination of fabric and ARTICO Leather¹. Depending on the line, there are up to four appointment colours to choose from, including black, royal blue, pebble beige and alpaca grey. All lines now also have new trim parts: in Olive ash wood in the CLASSIC model, in Laurel wood in the ELEGANCE and in Alu-linea aluminium in the AVANTGARDE.

Bird's-eye maple wood trim is also available as an optional extra for the AVANTGARDE. Chrome trim strips in the interior and chrome rings for the instrument cluster, with its new 4-tube design, add a distinctive finishing touch to all lines.

¹ Man-made leather



From left to right: CLASSIC, ELEGANCE, AVANTGARDE



Standard equipment

Selection

3-point seat belts and head restraints for all seats (NECK-PRO head restraints for driver and front passenger)
Airbag (two-stage) for driver and front passenger
Armrest, front with stowage compartment, cup holder in front and in rear armrest
ASSYST service interval indicator
Belt tensioners with belt force limiters, front and outer rear seats
Brake Assist (BAS)
Brake pad wear indicator
Central locking (remote control with selective and global opening)
Clear-lens fog lamps
Cruise control with SPEEDTRONIC variable speed limiter
DIRECT CONTROL 6-speed manual transmission ¹
DIRECT CONTROL power steering with safety steering column
DIRECT CONTROL suspension
Electronic Stability Program (ESP®)
Front seats with electrically adjustable height and backrest angle
Headlamp Assist
Heated exterior mirrors, electrically adjustable, aspherical, with clear-lens indicators

Heated rear window with time relay
High gloss-look clear-lens headlamps
High gloss-look tail lights
High gloss-look third brake light
Immobiliser with ELCODE locking system and infrared remote control
Multifunction steering wheel with trip computer
Outside temperature display
Particulate filter for diesel models
Power windows, 4, with one-touch control
Remote boot lid release
Seat occupancy sensor for front passenger seat
Sidebags for driver and front passenger
Steering column manually adjustable for height and reach
THERMATIC automatic climate control
Tinted windows
Windowbag for driver, front passenger and rear passengers
Windscreen washer system with heated nozzles

¹In the C 280 4MATIC, C 350 4MATIC and C 55 AMG, the 5-speed automatic transmission is standard

The equipment lines compared

<i>Selection</i>	<i>CLASSIC</i>	<i>ELEGANCE</i>	<i>AVANTGARDE</i>
Bumpers/rub strips	painted in vehicle colour	painted in vehicle colour with chrome trim strip	painted in vehicle colour with chrome trim strip
Centre console	Olive ash wood	Laurel wood	Alu-linea aluminium
Door handles	black coated	painted in vehicle colour with chrome trim strip	painted in vehicle colour
Door trim	-	Laurel wood	Alu-linea aluminium
Fabric design	Bristol	Windsor	Coventry ¹
Lettering on rub strips	-	ELEGANCE	AVANTGARDE
Radiator grille louvres	atlas grey	high-sheen atlas grey with chrome highlights	high-sheen black with chrome highlights
Steering wheel, shiftgate surround and gearshift lever	plastic, black	leather, to match interior appointments	leather, to match interior appointments
Waistline trim	haematite	high-sheen black with chrome edge	high-sheen black with chrome edge
Wheels	steel wheel, 16-inch, with wheel trim	light-alloy wheel, 16-inch, design specific to line	light-alloy wheel, 16-inch, mixed-size tyres design specific to line
Windows	green tinted glass, water-deflectors/roof trim strips powder-coated, deep dark grey	green tinted glass, water-deflectors/roof trim strips anodised aluminium, haematite black	blue tinted glass, water-deflectors/roof trim strips anodised aluminium, haematite black

- Not available

¹ Combined fabric/ARTICO Leather (man-made leather) upholstery

Extra-large filler cap available as an option: top up with sunshine

The C-Class offers you superb levels of comfort – as our extensive range of optional extras amply demonstrates. Take, for example, the electric tilting/sliding glass sunroof. It brightens up any journey, providing even more sunlight, more fresh air and greater transparency.



Optional extras

Selection

5-speed automatic transmission ¹
7G-TRONIC 7-speed automatic transmission ²
AMG sports package ³
Anti-theft alarm system (ATA) with tow-away protection and interior monitoring
Audio 20 CD radio
Audio 50 APS radio with CD drive
Auxiliary heater with remote control
Bi-xenon headlamps with cornering light function ³
CD changer (for 6 CDs) in glove compartment, MP3-compatible
COMAND APS control and display system with DVD drive
Electric tilting/sliding glass sunroof
Exterior mirrors left and right, folding and automatically dimming
Front seat right electrically adjustable with memory function ⁴
harman/kardon LOGIC 7 [®] surround sound system
Headlamp cleaning system

¹Standard for C 280 4MATIC, C 350 4MATIC and C 55 AMG

²Available for C 320 CDI, C 230, C 280 and C 350

³Cornering light function not available in conjunction with AMG sports package or C 55 AMG

⁴Only in conjunction with memory package

⁵Not available for C 240 4MATIC, C 320 4MATIC or C 55 AMG

Heated front seats
Leather steering wheel and shift/selector lever for C-Class CLASSIC
Leather upholstery
LINGUATRONIC voice control system
Memory package for driver's seat, exterior mirrors and steering column
PARKTRONIC
Pre-installation for mobile phone
Rain sensor for windscreen wipers
Sidebags in rear
Sports package ⁵
Sports suspension ⁵
Steering wheel gearshift buttons (in conjunction with automatic transmission)
THERMOTRONIC luxury automatic climate control
Through-loading facility with load anchorage points and folding rear seat with 1/3:2/3 split
Tyre pressure loss warning system

How about some sporty footwear for the C-Class Saloon?

The 17-inch, twin-spoke wheels, with size 225/45 tyres at the front and size 245/40 tyres at the rear, are available for all lines.

The sports package features 17-inch, 5-spoke light-alloy wheels, with size 225/45 tyres at the front and size 245/40 tyres at the rear, and 16-inch, 7-spoke wheels with size 205/55 tyres are also available for the CLASSIC and ELEGANCE lines



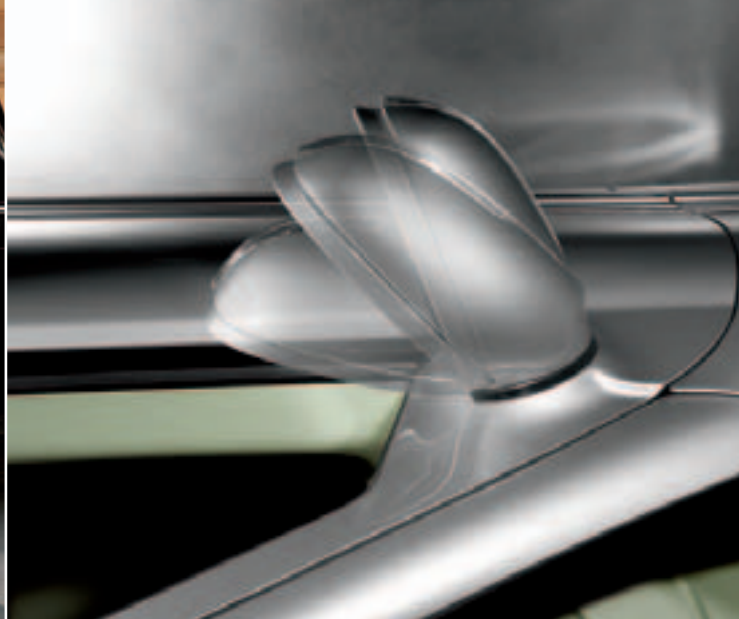

A technological experience: electrically folding exterior mirrors with an automatic dimming function are available as an optional extra. And the optional PARKTRONIC system helps make parking a breeze. Ten sensors emit ultrasonic signals which are reflected by any obstacles in the vehicle's path. A microcomputer continuously calculates how far away you are from these obstacles and uses displays on the dashboard and in the rear of the interior plus audible signals to keep you informed



The COMAND APS control and display system (left) features an integral radio and DVD navigation module. The LCD screen provides a clear overview. As a navigation system, COMAND APS makes your travels particularly enjoyable, while the optional harman/kardon LOGIC 7® surround sound system transforms your C-Class into a concert hall. The optional THERMOTRONIC luxury climate control uses sensors to regulate the interior temperature and the humidity. The 7G-TRONIC 7-speed automatic transmission ensures low consumption and powerful acceleration





If there's still not enough space for you, why not consider an extension?

A variety of attractive and practical accessories is being made available for the C-Class from day one. The Mercedes-Benz roof box, for example, offers 330 litres of extra stowage space and has an eye-catching design too. Equally practical is the Alustyle ski and snowboard rack – each one holds up to 4 pairs of skis or 2 snowboards. Mercedes-Benz child seats are available to ensure that children are able to travel safely in the C-Class from the start. They adapt to the size of your child and always allow plenty of freedom of movement. The child seats reflect our latest safety research findings.

Because freedom of movement and comfort are concepts which are inextricably linked, there's a universal coolbox to keep your refreshments cool while you're on the move. For details of the other products to be found in our range of accessories, see our special brochures or contact your Mercedes-Benz dealer.

Accessories





Give your C-Class that personal touch

Your personality should be reflected in the things that give you pleasure day after day – like your C-Class Saloon. The designo range was developed with this in mind: the designo specialists – responsible for exclusive details at Mercedes-Benz – have come up with a selection of special paint finishes and interior appointments from which you can select your own personal preferences.

When it comes to interior trim, you can choose between fine anthracite cinnamora wood and striking designo brown poplar. The seats, in embossed designo leather, meet the same high design standards. The single-tone designo leather seats are available in different standard colours depending on the equipment line. The two-tone appointments are available in a combination of black and a choice of ten designo leather colours. Further details and information can be found in the current designo brochure.

designo



**Non-metallic
paint**

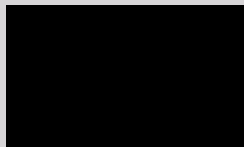

040 black



590 fire opal

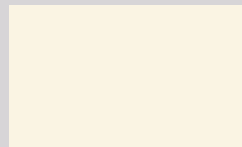

960 alabaster white

**Metallic paint
optional extra**

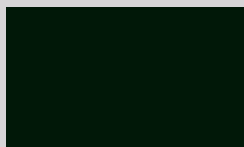

197 obsidian black

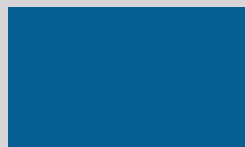

345 jasper blue¹

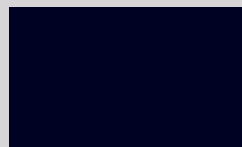

359 tanzanite blue



544 carneol red



723 cubanite silver



747 perlite grey

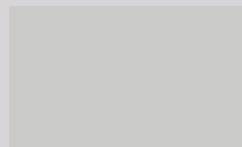

775 iridium silver



816 andradite green¹

**Special
metallic paint
optional extra for
AVANTGARDE**

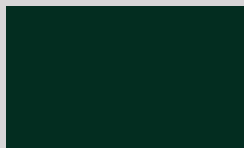

768 diamond black

¹Not available for C 55 AMG

Olive ash wood
standard for
CLASSIC



Laurel wood
standard for
ELEGANCE

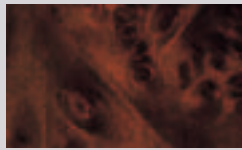

Alu-linea
aluminium
standard for
AVANTGARDE
and C 55 AMG



Bird's-eye
maple wood
optional extra for
AVANTGARDE
and C 55 AMG

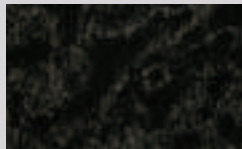

Bristol fabric
standard for
CLASSIC



011 black



012 royal blue



018 alpaca grey

Windsor fabric
standard for
ELEGANCE

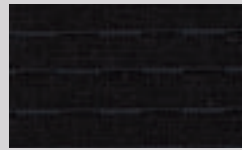

411 black

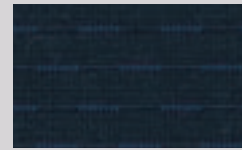

412 royal blue

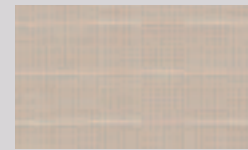

415 pebble beige



418 alpaca grey

Coventry fabric
standard for
AVANTGARDE

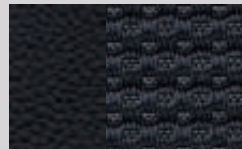

711 black



718 alpaca grey

¹ Combined fabric/ARTICO Leather (man-made leather) upholstery

TWIN Leather
*optional extra for
CLASSIC and
ELEGANCE*



111 black²

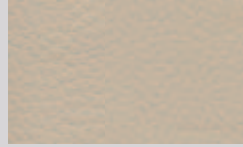

115 pebble beige



118 alpaca grey

Leather
*optional extra for
ELEGANCE*



212 royal blue

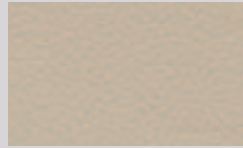

215 pebble beige

Leather
*optional extra for
ELEGANCE and
AVANTGARDE*



211 (E), 221 (A) black



218 (E), 228 (A) alpaca grey

Nappa leather
*available only as
standard for
C 55 AMG*



841 black



848 alpaca grey

designo
*trim
optional extra*



W52 anthracite cinnamora

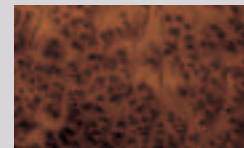

W68 brown poplar

¹Combined leather/man-made leather upholstery ²Standard with sports package and AMG sports package

Paintwork and upholstery – the combination options

	<i>Bristol fabric</i>			<i>Windsor fabric</i>				<i>Coventry fabric¹</i>		<i>Leather / TWIN Leather²</i>				<i>Nappa leather³</i>	
	black	royal blue	alpaca grey	black	royal blue	pebble beige	alpaca grey	black	alpaca grey	black	royal blue	pebble beige	alpaca grey	black	alpaca grey
<i>Non-metallic paint</i>															
black	●	△	●	●	△	●	●	●	●	●	△	●	●	●	●
fire opal	●	△	○	●	△	○	○	●	○	●	△	○	○	●	○
alabaster white	●	●	●	●	●	○	●	●	●	●	●	○	●	●	●
<i>Metallic paint</i>															
obsidian black	●	△	●	●	△	●	●	●	●	●	△	●	●	●	●
jasper blue	●	△	○	●	△	△	○	●	○	●	△	△	○	-	-
tanzanite blue	●	●	●	●	●	●	●	●	●	●	●	●	●	●	●
carneol red	●	△	●	●	△	●	●	●	●	●	△	●	●	-	-
cubanite silver	●	●	●	●	●	○	●	●	●	●	●	○	●	●	●
perlite grey	●	●	●	●	●	○	●	●	●	●	●	○	●	●	●
iridium silver	●	●	●	●	●	△	●	●	●	●	●	△	●	●	●
andradite green	●	△	○	●	△	●	○	●	○	●	△	●	○	-	-
<i>Special metallic paint</i>															
diamond black	-	-	-	-	-	-	-	●	●	●	-	-	●	●	●

● Recommended ○ Possible △ Not recommended – Not available

¹Combined fabric/ARTICO Leather (man-made leather) upholstery ²Combined leather/man-made leather upholstery ³Available for C 55 AMG only

Technical data

	<i>C 200 CDI</i>	<i>C 220 CDI</i>	<i>C 320 CDI</i>	<i>C 180 KOMPRESSOR</i>	<i>C 200 KOMPRESSOR</i>
No. of cylinders/arrangement	4/in-line	4/in-line	6/V	4/in-line	4/in-line
Bore/stroke (mm)	88.0/88.3	88.0/88.3	83.0/92.0	82.0/85.0	82.0/85.0
Total displacement (cc)	2148	2148	2987	1796	1796
Rated output (kW at rpm) ¹	90/4200	110/4200	165/3800	105/5200	120/5500
Rated torque (Nm at rpm) ¹ (automatic transmission)	270/1600–2800 (270/1600–2800)	340/2000 (340/2000)	415/1400–3800 (510/1600–2800)	220/2500–4200 (220/2500–4200)	240/3000–4000 (240/3000–4000)
Compression ratio	18.0	18.0	17.7	10.0	9.3
Acceleration 0–100 km/h (s) (automatic transmission)	11.7 (11.9)	10.1 (10.3)	8.1 (7.2)	9.7 (9.9)	9.3 (9.3)
Top speed, approx. (km/h) (automatic transmission)	208 (203)	224 (218)	246 (250 ²)	223 (220)	234 (231)
Tyre size	front rear	front rear	front rear	front rear	front rear
	205/55 R 16 205/55 R 16	205/55 R 16 205/55 R 16	225/45 R 17 225/45 R 17	205/55 R 16 205/55 R 16	205/55 R 16 205/55 R 16
Fuel	Diesel	Diesel	Diesel	Premium	Premium
Fuel consumption (l/100 km) ³					
urban (automatic transmission)	8.5–8.7 (8.9–9.1)	8.6–8.8 (9.0–9.2)	9.8–10.1 (10.1–10.5)	11.4–11.6 (11.7–12.0)	11.9–12.4 (12.1–12.7)
extra-urban (automatic transmission)	5.1–5.2 (5.6–5.7)	5.1–5.2 (5.4–5.5)	5.3–5.5 (5.7–5.9)	5.9–6.4 (6.1–6.6)	6.4–6.9 (6.5–6.7)
combined (automatic transmission)	6.3–6.5 (6.9)	6.4–6.5 (6.8–6.9)	6.9–7.2 (7.3–7.6)	7.9–8.3 (8.2–8.5)	8.4–8.9 (8.5–8.9)
CO ₂ emissions (g/km) ³ (automatic transmission)	156–167 (166–178)	159–164 (172–174)	183–190 (192–201)	190–198 (193–203)	200–212 (202–212)
Tank capacity, incl. reserve, approx. (l)	62/8	62/8	62/8	62/8	62/8
Turning circle diameter (m)	10.76	10.76	10.76	10.76	10.76
Kerb weight ⁴ /Perm. GVW (kg)	1515/1995	1540/2020	1630/2110	1485/1965	1485/1965

<i>C 230</i>	<i>C 280</i>	<i>C 280 4MATIC</i>	<i>C 350</i>	<i>C 350 4MATIC</i>	<i>C 55 AMG</i>
6/V	6/V	6/V	6/V	6/V	8/V
88.0/68.4	88.0/82.1	88.0/82.1	92.9/86.0	92.9/86.0	97.0/92.0
2496	2996	2996	3498	3498	5439
150/6100	170/6000	170/6000	200/6000	200/6000	270/5750
245/2900 – 5500 (245/2900 – 5500)	300/2500 – 5000 (300/2500 – 5000)	– (300/2500 – 5000)	350/2400 – 5000 (350/2400 – 5000)	– (350/2400 – 5000)	– (510/4000)
11.2	11.1	11.1	10.5	10.5	11.0
8.4 (8.9)	7.3 (7.2)	– (7.6)	6.4 (6.4)	– (6.9)	– (5.2)
245 (238)	250 ² (250 ²)	– (247)	250 ² (250 ²)	– (250 ²)	– (250 ²)
205/55 R 16	205/55 R 16	205/55 R 16	225/45 R 17	205/55 R 16	225/40 R 18
205/55 R 16	205/55 R 16	205/55 R 16	225/45 R 17	205/55 R 16	245/35 R 18
Premium	Premium	Premium	Premium	Premium	Super Plus
13.5 – 13.8 (13.2 – 13.5)	13.7 – 14.0 (13.3 – 13.6)	– (13.7 – 13.9)	13.7 – 14.0 (13.9 – 14.2)	– (14.4 – 14.7)	– (17.3)
6.8 – 7.1 (7.1 – 7.4)	6.9 – 7.2 (7.2 – 7.5)	– (7.5 – 7.8)	7.0 – 7.3 (7.3 – 7.6)	– (7.9 – 8.2)	– (8.8)
9.3 – 9.6 (9.3 – 9.6)	9.4 – 9.7 (9.4 – 9.7)	– (9.8 – 10.1)	9.5 – 9.8 (9.7 – 10.0)	– (10.3)	– (11.9)
222 – 229 (222 – 225)	225 – 232 (225 – 232)	– (233 – 241)	227 – 234 (232 – 239)	– (248 – 253)	– (286)
62/8	62/8	62/8	62/8	62/8	62/8
10.76	10.76	10.76	10.76	10.76	10.76
1530/2010	1535/2015	1640/2120	1555/2030	1655/2135	1635/2115

¹ Figures according to Directive 80/1269/EEC in the currently applicable version ² Electronically governed ³ The figures shown were obtained in accordance with the prescribed measuring process (Directive 80/1268/EEC in the currently applicable version). The figures are not based on an individual vehicle and do not constitute part of the product offer; they are provided solely for purposes of comparison between different vehicle models ⁴ Figures according to Directive 92/21/EC, version 95/48/EC (kerb weight with fuel tank 90 % full, driver, 68 kg, and luggage, 7 kg) for standard-specification vehicles only. Optional extras and accessories will generally increase this figure and reduce the payload capacity accordingly

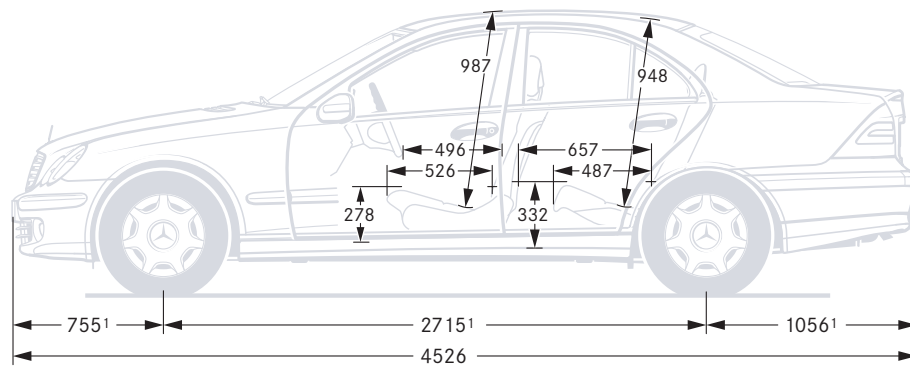
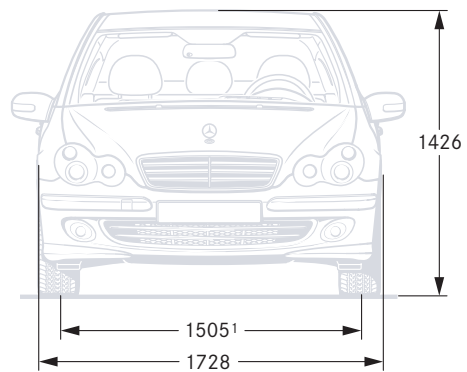

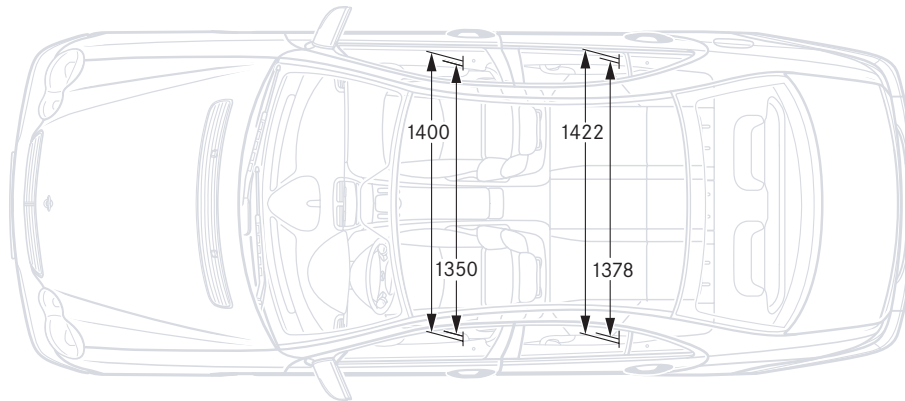
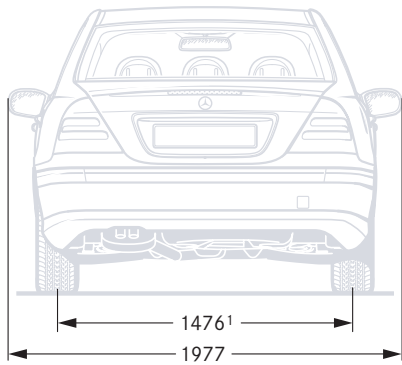

The dimensions, shown in mm, are average values for the unladen, standard-specification vehicle
¹Carrying three people, each weighing 68 kg; vehicle without number plate adapter (6 mm)

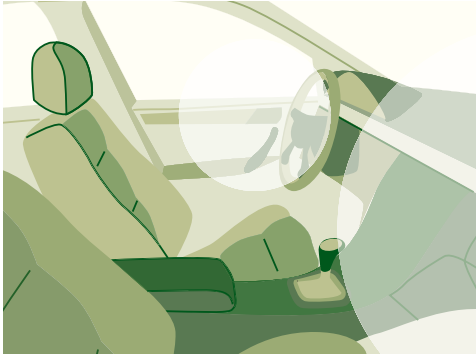

Airbags and belt system

The C-Class is fitted with selective front airbags plus sidebags and windowbags, all of which are activated in accordance with the type and severity of a collision. In the event of a frontal collision the electronics deploy the front airbags in two stages, depending on the severity of the accident, offering the front occupants an appropriate level of protection. The sidebags provide increased protection for the chest area, while the windowbags offer protection for the head, expanding like a curtain between the A and C-pillars. Belt tensioners on the front and on the outer rear seats pull the belts against the body in fractions of a second in the event of a frontal or rear-end collision of a specific severity.



NECK-PRO

The new NECK-PRO head restraint system for the driver and front passenger responds rapidly to support the head in the event of a rear-end collision. Sensors trigger pre-stressed springs, moving the head restraints forward 44 mm and up 30 mm. NECK-PRO thereby helps to minimise the risk of possible whiplash injuries in a rear-end collision. Once triggered, the head restraints can be returned to their original position manually.

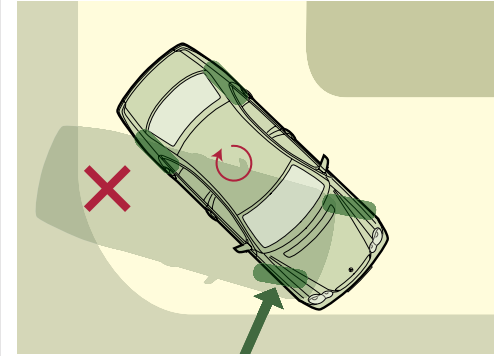

ESP® with tyre pressure loss warning system

If your car is in danger of skidding, the Electronic Stability Program (ESP®) is instantly activated. The sensors recognise critical dynamic handling situations at an early stage, e.g. the fact that a wheel is spinning or is in danger of losing contact with the road. ESP® throttles back the engine torque and brakes one or more wheels as required in order to stabilise the vehicle. The integral tyre pressure loss warning function can detect severe loss of pressure in a tyre and indicates this in the instrument cluster. It is still vital, however, that you check the tyre pressure and condition on a regular basis.

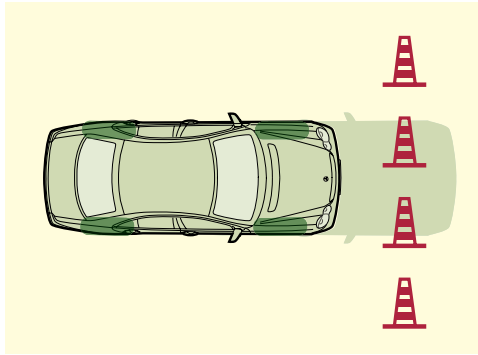

BAS

The electronic Brake Assist system (BAS) recognises emergency braking by the speed with which you apply the brake and instantly builds up the maximum braking force, bringing the car to a standstill faster. Thanks to the anti-lock braking system (ABS), the wheels do not lock when automatic emergency braking is triggered, and the car remains steerable. When the driver takes his or her foot off the brake pedal again, the automatic brake booster is deactivated.

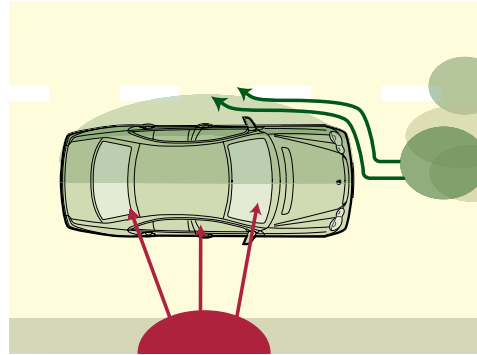

THERMOTRONIC luxury automatic climate control

The driver and front passenger can each configure their own preferred temperature and airflow settings. Sensors monitor the intensity of the sunlight, while the intake-air quality is improved by a dust filter and an activated charcoal filter. The interior temperature and blower settings are adjusted automatically to create a pleasant atmosphere. A dew-point sensor monitors air humidity to prevent the windows from misting up. The control unit's clear display makes the system simple to use.

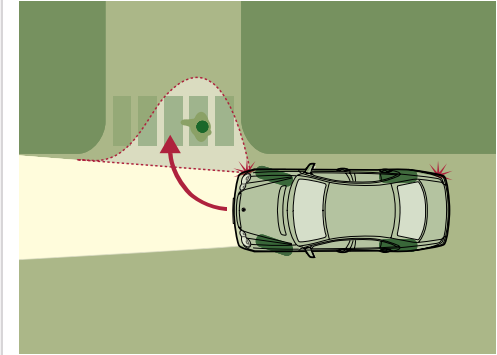

Cornering light function

The cornering light function is an extended feature of the optional bi-xenon headlamps. By dispersing the light from the fog lamp more widely, the cornering light ensures significantly better illumination of the road into which the vehicle is turning. The left or right fog lamp is activated when the headlamps are on, the vehicle speed is below 40 km/h and the indicator is on or the relevant steering angle is achieved. The cornering light function means that pedestrians and potential obstacles can be detected at an early stage and accidents avoided.

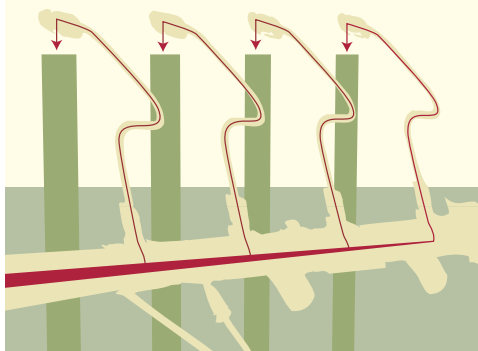

Common-rail diesel engines

Smooth and quiet operation, economy, low emissions and driving pleasure – the special qualities of the common-rail diesel engines. Responsible for this all-round talent is a common fuel supply pipe, or rail, which keeps the fuel at a permanently high pressure of around 1600 bar throughout the entire engine speed range and injects finely atomised, precisely metered quantities of fuel into the combustion chambers. The result is a reduction in fuel consumption and lower pollutant emissions. Noise emissions and engine vibration have also been significantly reduced. The good torque values are the result of, among other things, the turbocharger with a variable nozzle turbine (VNT) and the charge-air cooling.

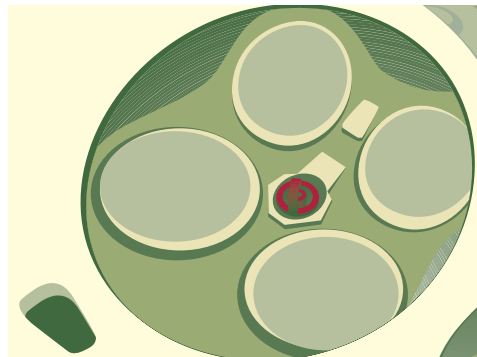

6-cylinder petrol engines with 4 valves per cylinder

4-valve technology, combined with adjustable intake and exhaust camshafts improves the rated output and torque of the new V6 engines across a broad engine speed range. The sophisticated air intake concept and the optimised combustion chamber design also lowers fuel consumption and exhaust emissions. A balancer shaft ensures quieter engine operation and reduces vibrations.



7G-TRONIC

The world's first 7-speed automatic transmission ensures barely perceptible gearshifts, even in the upper gears. Thanks to the integral transmission control, with faster direct control of the gears, which allows several gears to be skipped, pulling power and acceleration are significantly enhanced. A second reverse gear with a higher transmission ratio makes pulling away on ice and snow easier and safer. The seven gears make for smaller shifts in engine speed. The torque converter helps reduce consumption while enhancing acceleration. Noise emissions remain low.

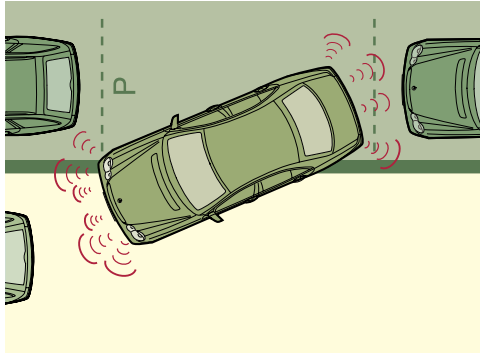

PARKTRONIC

This electronic system helps you to park and to manoeuvre your way out of a tight parking spot. Like a depth sounder, it sends out ultrasonic signals which are bounced back off obstacles in your vehicle's path. Displays in the interior show how close the vehicle is to a detected obstacle. Depending on the distance, yellow or red signals provide warnings. If the gap falls below a certain limit, PARKTRONIC also emits a continuous acoustic warning.



COMAND APS

A DVD navigation module (for most European countries) can be added to the COMAND control and display system to create COMAND APS. It works with the Global Positioning System (GPS). Enter your destination into the system, and COMAND APS works out the route. Voice instructions or direction arrows in the display tell you which way to go. Dynamic route guidance is an additional service (available in Germany and some other European countries), which uses information provided by radio stations to guide you around tailbacks where there is an alternative route.



LINGUATRONIC

To operate the telephone, the audio/video system and the navigation system, all you need is your voice and LINGUATRONIC. The system helps enhance safety since it allows you to keep both hands on the steering wheel. If LINGUATRONIC is activated, you can use a selection of easy-to-remember commands to save numbers, for example, access your phone book and make phone calls. Many other functions, such as selecting a waveband and searching for a station, can also be voice-controlled. It is now also possible to input destination details for the navigation system orally and to voice-control other functions.

Our service is your gateway to the world



www.mercedes-benz.com

Step into the world of Mercedes-Benz on-line and find out more about the brand. From its history, for example in our virtual museum to the company's latest innovations, for example in the far-sighted field of fuel cell technology. Our technology glossary keeps you up-to-date with new developments. Cars and culture? Mercedes-Benz is well-known for its sponsorship programmes, so it's only logical that we also provide you with up-to-the-minute information on motor shows, exhibitions, international fashion trends, fashion weeks and sports events. Have we awakened your interest in motorsport? Formula 1? On-line you can find all the latest results and news, and even order tickets. And of course we haven't forgotten the children. In Cedy's World there are games, a forum where your children can meet others and plenty of opportunities to learn all about cars, technology and the environment. As you can see, the virtual world can sometimes be as exciting as the real one.

MobiloLife

With MobiloLife, our mobility and warranty package, you can expect years of carefree driving. Whether you have lost your key, are having problems starting the car or it breaks down and cannot be repaired immediately, the mobility package ensures that you still reach your destination, in almost every country in Europe. Under certain circumstances we even meet the cost of an airline ticket. And if help takes longer than expected, we put you up in a hotel of your choice. But don't get too excited – it's very rare for a Mercedes to break down. Call Mercedes-Benz on 00800 1777 7777 from almost any European terrestrial or mobile network and our Service 24h team will assist you in your own language. Our staff are there for you 24 hours a day, 365 days a year. Your vehicle documents provide details of the alternative phone numbers for each country. MobiloLife will also help if you bring your car in for a major warranty or policy repair; it applies to a new vehicle for a period of 2 years and is then automatically renewed every time a service is carried out by a Mercedes-Benz service centre, remaining valid until the next service is due – for a maximum of 30 years. Our service even includes a warranty against rusting through from the inside. For more detailed information on MobiloLife, see your vehicle documents.

MercedesCard

There's also a wealth of experiences to enjoy when you're not sitting at the wheel of your Mercedes-Benz. Owning a MercedesCard is all it takes. It acts as your ticket to the world of Mercedes-Benz and doubles as a practical credit card. The MercedesCard Journal contains details of a selection of sporting, cultural and travel events, put together especially for you. For further information call 00800 – 6200 3190 in Germany, 0800 – 55 79 84 in Switzerland or 0800 – 20 65 65 in Austria.

DaimlerChrysler Bank – financial services

If you have already set your heart on your dream Mercedes and want to remain flexible in financial terms, our leasing, financing and insurance packages could be exactly what you're looking for. The on-line calculator allows you to work out your monthly payments for yourself. In addition to individually geared financial services, we can also offer you tailor-made investment products. For further information call us on 0 18 03 – 32 22 65 (9 ct/min) or 0 18 03 – DC BANK (9 ct/min) or visit www.daimlerchrysler-bank.com

Interactive Owner's Manual

Almost as good as a test drive: the interactive Owner's Manual from Mercedes-Benz. Find out for yourself how it will feel to drive your new Mercedes – it's an experience that's only a mouse click away. Our website features informational clips and simulations designed to help you familiarise yourself with the various functions of your new car.

Discover the technical facts and figures and get a clear picture of the features that await you inside – including the multifunction steering wheel and the COMAND APS navigation system. For further details, go to www.mercedes-benz.de/betriebsanleitung



S 0A 5665



C 350 AVANTGARDE with sports package

Take-back of end-of-life vehicles. Coming full circle

At the end of its long life, you can return your C-Class Saloon to us for environment-friendly disposal in accordance with the EC End-Of-Life Vehicle Directive.¹
But that day lies a long way off.

¹Applies in accordance with national regulations to vehicles up to 3.5 t permissible gross weight. The C-Class Saloon has met the statutory regulations governing the suitability of the vehicle's design for reuse and recycling for a number of years now. A network of vehicle take-back depots and dismantlers has been established which will process your vehicle in an environment-friendly manner. The ways in which both vehicles and parts can be recovered are subject to ongoing development and improvement. Consequently, the C-Class Saloon will be able to comply with any future increases in the recycling quota within the stipulated time limits.

For further information, please call 00800 1777 7777

Please note: changes may have been made to the product since this brochure went to press (31.07.05). The manufacturer reserves the right to make changes to the design, form, colour and specification during the delivery period, provided these changes, while taking into account the interests of the vendor, can be deemed reasonable with respect to the purchaser. Where the vendor or the manufacturer uses symbols or numbers to describe an order or the subject of an order, no rights may be derived solely from these. The illustrations may show accessories and items of optional equipment which are not part of standard specification. Colours may differ slightly from those shown in the brochure, owing to the limitations of the printing process.

This brochure has been compiled by DaimlerChrysler AG of Germany and is distributed internationally. It provides a general indication of the range of models, features, optional extras and/or colours available in various countries. Some of the models, features, optional extras and/or colours shown may not be available in your country or may only be available in a different specification. Additionally some models, features, optional extras and/or colours may only be available in combination with others. For current and more specific information in relation to the range of models, features, optional extras and/or colours available in your country, and their pricing, you should contact your nearest authorised Mercedes-Benz Passenger Car Dealer.